

## Basisinformation

### Lichtkuppel



Lichtkuppel geschlossen



Lichtkuppel geöffnet in Lüftungsstellung

### Vielseitiges Zubehör

- Verschattungsvarianten
- Anschlussmöglichkeiten / Sanierungsoptionen
- Verschiedene Antriebsmotoren
- Smart Home (elektrische Ansteuerungen)
- LED-Ausstattung

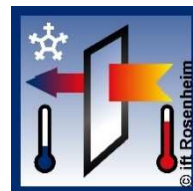

Verglasung  
U<sub>t</sub> bis 1,0 W/m<sup>2</sup>K



Wasserdicht  
nach EN 1873



Driven Rain Index  
DRI bis 14,7m<sup>2</sup>/s



Windlast bis  
UL 1780  
nach EN 1873

### Materialien u. Baustoffklassen

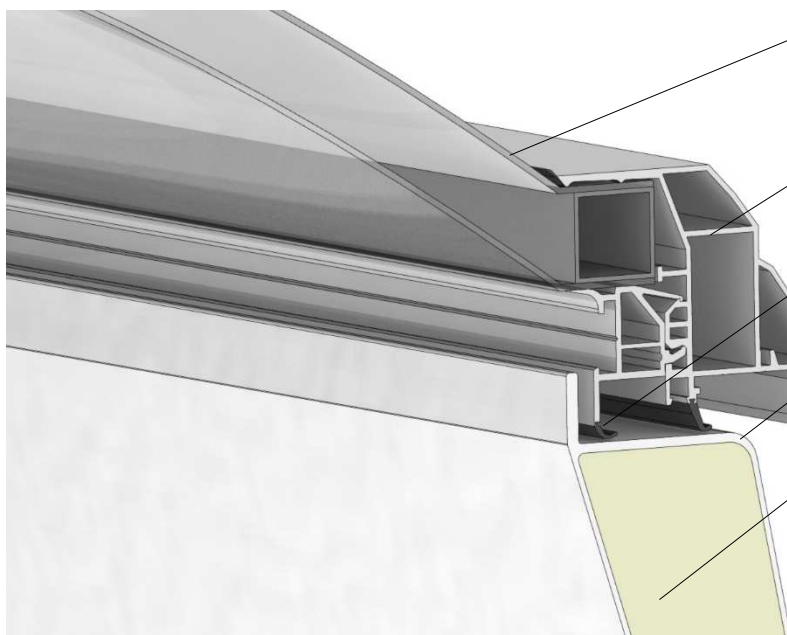

Verglasung aus Kunststoff | E-d0

PVC Einfassrahmen (RAL 9016) | E-d0

TPE Lippendichtung 2-Fach | E-d0

GFK-Außenschale (RAL 9016) | E-d0

PU-Hartschaumdämmung | E-d0

Basisinformation

**Verglasung**



**Doppel-Schalig**  
 $U_t$  ca. 2,7 W/m<sup>2</sup>K

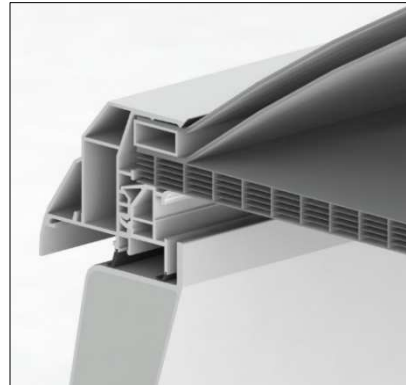

**Doppel-Schalig + PC16**  
 $U_t$  ca. 1,3 W/m<sup>2</sup>K

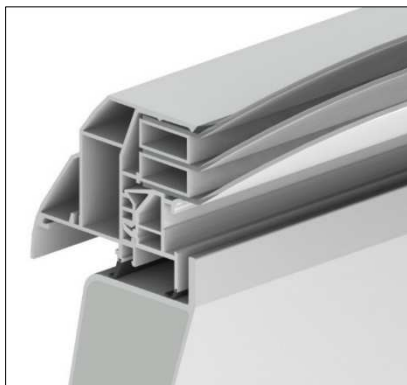

**Drei-Schalig**  
 $U_t$  ca. 1,8 W/m<sup>2</sup>K



**Vier-Schalig**  
 $U_t$  ca. 1,5 W/m<sup>2</sup>K

### Basisinformation

Typ	Material	Außen- schale	Mittel- schale	Innen- schale	Licht- transmission τ [%]	Gesamtener- giedurchlass g [%]	Schall- dämmmaß Rw [dB]	Wärme- durchgang Ut [W/m²K]	Baustoff- klasse (DIN 4102-1)	nicht brennend abtropfend	Baustoff- klasse (DIN EN 13501)	harte Bedachung (EN 13501-5)	Durchsturz- sicher (GS-Bau 18)	Hagelwider- standsklasse (Dichtheit)	Hagelwider- standsklasse (Lichtdurch- lässigkeit)
zwei- schalig	Kunststoff	opal	–	opal	70%	70%	24	2,7	-	•	E, d0	–	–	–	–
	Kunststoff	opal	–	klar	78%	78%	24	2,7	-	•	E, d0	–	–	–	–
	Kunststoff	klar	–	klar	86%	86%	24	2,7	-	•	E, d0	–	–	–	–
	Kunststoff	heatstop	–	opal	49%	37%	24	2,7	-	•	E, d0	–	–	–	–
	Kunststoff	heatstop	–	klar	54%	41%	24	2,7	-	•	E, d0	–	–	–	–
	Kunststoff schlagzäh	opal	–	opal	56%	56%	24	2,6	B1	•	B-s1, d0	–	–	HW5	HW5
	Kunststoff schlagzäh	opal	–	klar	66%	66%	24	2,6	B1	•	B-s1, d0	–	–	HW5	HW5
	Kunststoff schlagzäh	klar	–	klar	77%	77%	24	2,6	B1	•	B-s1, d0	–	–	HW5	HW5
	Kunststoff schlagzäh + Kunststoff	opal schlagzäh	-	opal	63%	63%	-	2,7	-	•	E, d0	–	–	HW5	HW5
drei- schalig	Kunststoff	opal	opal	opal	59%	59%	21	1,8	–	•	E, d0	–	–	–	–
	Kunststoff	opal	klar	opal	66%	66%	21	1,8	–	•	E, d0	–	–	–	–
	Kunststoff	opal	klar	klar	73%	73%	21	1,8	–	•	E, d0	–	–	–	–
	Kunststoff	klar	klar	klar	80%	80%	21	1,8	–	•	E, d0	–	–	–	–
	Kunststoff	klar	klar	opal	73%	73%	21	1,8	–	•	E, d0	–	–	–	–
	Kunststoff	heatstop	opal	opal	41%	31%	21	1,8	–	•	E, d0	–	–	–	–
	Kunststoff	heatstop	klar	opal	45%	34%	21	1,8	–	•	E, d0	–	–	–	–
	Kunststoff	heatstop	klar	klar	50%	38%	21	1,8	–	•	E, d0	–	–	–	–
	Kunststoff schlagzäh	opal	opal	opal	42%	42%	-	1,9	B1	•	E, d0	–	1 Jahr	HW5	HW5
	Kunststoff schlagzäh	opal	klar	opal	50%	50%	-	1,9	B1	•	E, d0	–	1 Jahr	HW5	HW5
	Kunststoff schlagzäh	opal	klar	klar	58%	58%	-	1,9	B1	•	E, d0	–	1 Jahr	HW5	HW5
	Kunststoff schlagzäh	klar	klar	klar	68%	68%	-	1,9	B1	•	E, d0	–	1 Jahr	HW5	HW5
Kunststoff schlagzäh + Kunststoff	opal schlagzäh	opal	opal	53%	53%	-	1,8	-	•	E, d0	–	–	HW5	HW5	
vier- schalig	Kunststoff	opal	klar/klar	opal	63%	63%	-	1,5	-	•	E, d0	–	–	–	–
	Kunststoff	opal	opal/opal	opal	50%	50%	-	1,5	-	•	E, d0	–	–	–	–
	Kunststoff	klar	klar/klar	opal	68%	68%	-	1,5	-	•	E, d0	–	–	–	–
	Kunststoff	klar	klar/klar	klar	75%	75%	-	1,5	-	•	E, d0	–	–	–	–
	Kunststoff	heatstop	klar/klar	opal	42%	32%	-	1,5	-	•	E, d0	–	–	–	–
	Kunststoff	heatstop	klar/klar	klar	47%	35%	-	1,5	-	•	E, d0	–	–	–	–
	Kunststoff schlagzäh	opal	klar/klar	opal	45%	45%	-	1,6	-	•	E, d0	–	1 Jahr	HW5	HW5
	Kunststoff schlagzäh	klar	klar/klar	opal	51%	51%	-	1,6	-	•	E, d0	–	1 Jahr	HW5	HW5
	Kunststoff schlagzäh	klar	klar/klar	klar	60%	60%	-	1,6	-	•	E, d0	–	1 Jahr	HW5	HW5
doppelschalig Kunststoff + PC16	Kunststoff + PC	opal	klar	Stegpl. opal	22%	36%	-	1,3	-	•	E, d0	–	–	–	–
		opal	klar	Stegpl. klar	44%	49%	-	1,3	-	•	E, d0	–	–	–	–
		klar	klar	Stegpl. klar	49%	54%	-	1,3	-	•	E, d0	–	–	–	–
einschalig Kunststoff schlagzäh + PC16	Kunststoff schlagzäh + PC	opal	-	Stegpl. opal	30%	34%	-	1,4	-	•	B-s2, d0	–	–	HW5	HW5
		opal	-	Stegpl. klar	43%	46%	-	1,4	-	•	B-s2, d0	–	–	HW5	HW5
		klar	-	Stegpl. opal	35%	39%	-	1,4	-	•	B-s2, d0	–	–	HW5	HW5
		klar	-	Stegpl. klar	50%	53%	-	1,4	-	•	B-s2, d0	–	–	HW5	HW5
doppelschalig Kunststoff schlagzäh + PC16	Kunststoff schlagzäh + PC	opal	klar	Stegpl. opal	18%	31%	-	1,3	-	•	B-s1, d0	–	–	HW5	HW5
		opal	klar	Stegpl. klar	37%	42%	-	1,3	-	•	B-s1, d0	–	–	HW5	HW5
		klar	klar	Stegpl. klar	44%	49%	-	1,3	-	•	B-s1, d0	–	–	HW5	HW5
doppelschalig PC massiv 3mm + PC16	PC massiv + PC	opal	klar	Stegpl. opal	18%	31%	-	1,3	-	•	E, d0	–	1 Jahr	HW5	HW5
		opal	klar	Stegpl. klar	37%	42%	-	1,3	-	•	E, d0	–	1 Jahr	HW5	HW5
		klar	klar	Stegpl. klar	44%	49%	-	1,3	-	•	E, d0	–	1 Jahr	HW5	HW5

Basisinformation

Typ	Material	Außen- schale	Mittel- schale	Innen- schale	Licht- transmission τ [%]	Gesamtener- giedurchlass- g [%]	Schall- dämmmaß Rw [dB]	Wärme- durchgang Ut [W/m²K]	Baustoff- klasse (DIN 4102-1)	nicht brennend abtropfend	Baustoffkla- sse (DIN EN 13501)	harte Bedachung (EN 13501-5)	Durchsturz- sicher (GS-Bau 18)	Hagelwider- standsklasse (Dichtheit)	Hagelwider- standsklasse (Lichtdurch- lässigkeit)
PC massiv	2-schalig	opal	–	opal	56%	56%	24	2,7	-	•	E, d0	–	1 Jahr	HW5	HW5
		opal	–	klar	66%	66%	24	2,7	-	•	E, d0	–	1 Jahr	HW5	HW5
		klar	–	klar	77%	77%	24	2,7	-	•	E, d0	–	1 Jahr	HW5	HW5
		klar	–	opal	66%	66%	24	2,7	-	•	E, d0	–	1 Jahr	HW5	HW5
	3-schalig	opal	opal	opal	42%	42%	21	2	-	•	E, d0	–	1 Jahr	HW5	HW5
		opal	klar	opal	50%	50%	21	2	-	•	E, d0	–	1 Jahr	HW5	HW5
		opal	klar	klar	58%	58%	21	2	-	•	E, d0	–	1 Jahr	HW5	HW5
		klar	klar	klar	68%	68%	21	2	-	•	E, d0	–	1 Jahr	HW5	HW5
	4-schalig	opal	klar/klar	opal	45%	45%	-	1,6	-	•	E, d0	–	1 Jahr	HW5	HW5
		klar	klar/klar	klar	60%	60%	-	1,6	-	•	E, d0	–	1 Jahr	HW5	HW5

Wellenzahl

OKD Langseite	Schräg	Steil
60	2	2
80	2	2
90	2	2
100	3	3
120	4	4
125	4	4
135	4	-
140	4	4
145	4	-
150	5	5
180	6	6
200	6	6
210	6	7
230	7	-
240	7	8
250	8	8
270	9	9
300	9	10

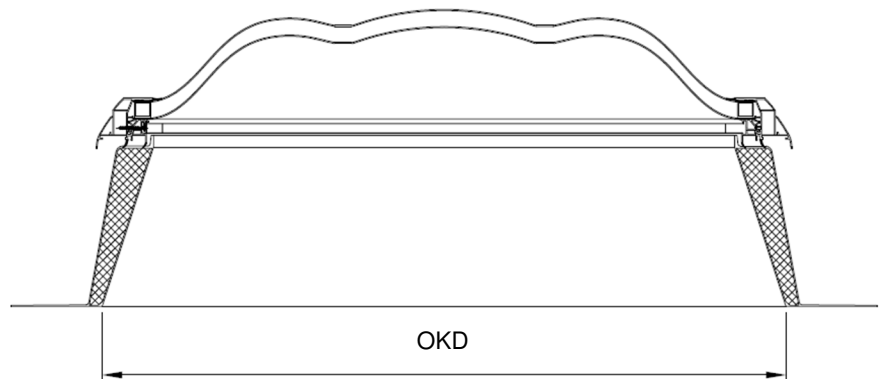

## Basisinformation

### Unterteil

#### Geometrie

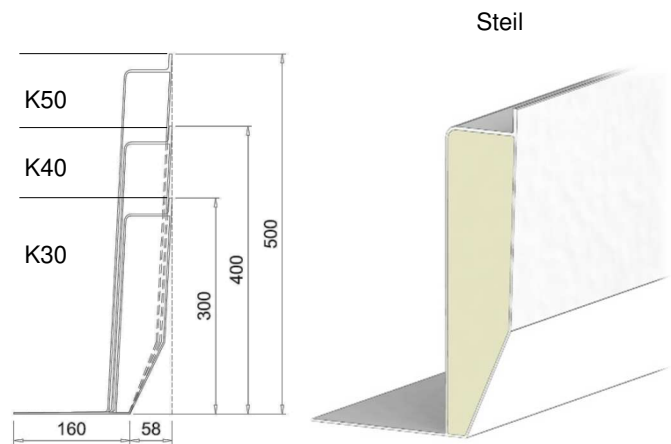
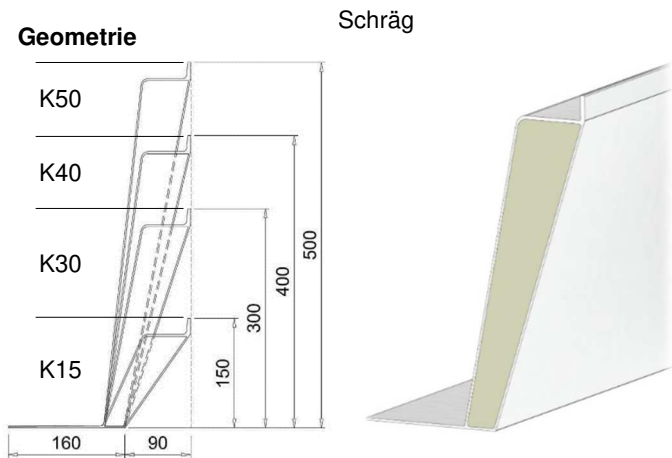

OKD 60/120, 90/90, 90/120, 90/145, 100/100, 100/150, 120/120, 120/240, 150/150, 150/250 und 180/180 auch in K70 lieferbar.

#### Material



GFRK-Aufsatzkranz  
 $U_{up}$  ca. 0,5 – 0,9 W/m<sup>2</sup>K \*



einteilig, fugenlos, gedämmt



Aluminium-Aufsatzkranz  
 $U_{up}$  ca. 1,8 – 6,7 W/m<sup>2</sup>K \*

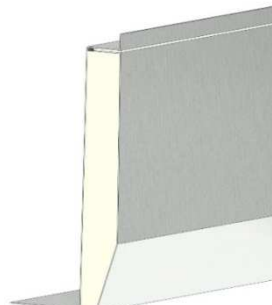

mehrteilig, Ecken verschweißt,  
 Kopf genietet, gedämmt





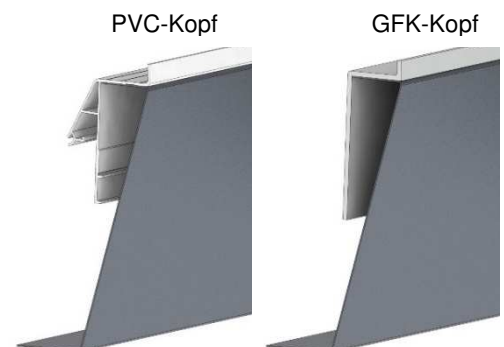









































Stahlblech-Aufsatzkranz  
 $U_{up}$  ca. 1,3 – 2,4 W/m<sup>2</sup>K \*  
 \*je nach Geometrie und Höhe



mehrteilig, Ecken gesteckt, Kopf geschraubt, optional gedämmt

## Basisinformation

OKD (cm)	Scharnier-seite	Lichtfläche in m <sup>2</sup>	
		schräg	steil
50/100		0,26	-
50/150		0,42	-
60/60		0,18	-
60/90		0,30	-
60/120		0,43	-
70/135		0,61	-
80/80		0,38	-
80/150		0,82	-
90/90		0,52	-
90/120		0,73	-
90/145		0,91	-
100/100		0,67	0,78
100/150		1,08	1,22
100/200		1,49	1,67
100/240		1,82	2,02
100/250		1,90	2,11
100/300		2,31	2,55
120/120		1,04	1,18
120/150		1,35	1,50
120/180		1,65	1,83
120/240		2,26	2,48
120/250		2,37	-
120/270		2,57	2,80
120/300		2,88	3,13
125/125		1,14	1,29
125/250		2,48	2,70
135/230		2,48	-
140/140		1,49	1,65
150/150		1,74	1,92
150/180		2,14	2,33
150/200		2,40	2,61
150/210		2,53	2,75
150/240		2,93	3,16
150/250		3,06	3,30
150/270		3,33	3,58
150/300		3,72	3,99
180/180		2,62	2,84
180/210		3,11	3,34
180/240		3,60	3,85
180/250		3,76	4,01
180/270		4,08	4,35
180/300		4,57	4,86
180/320		4,89	-
200/200		3,31	3,55
200/250		4,22	-
200/300	nur starr	5,13	-

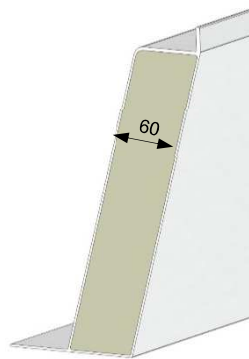

Bei GFK-Kränzen optional Dämmung durchgehend 60 mm  
U<sub>up</sub> ca. 0,5 W/m<sup>2</sup>K

### Schrägeometrie

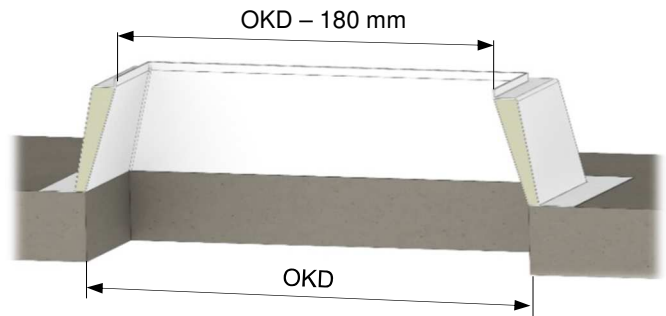

### Steilgeometrie

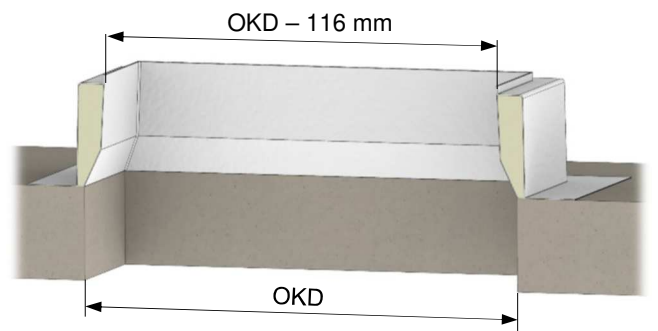

### Ausführungen Fußflansch

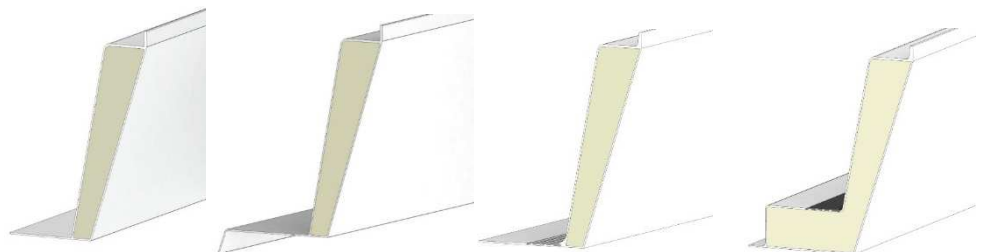

Standard Fußflansch

2- oder 4-seitig abgekanteter Fußflansch

flacher Fußflansch mit PVC Anschlusschiene

Wärmedämmter Fußflansch, optional mit PVC Anschlusschiene

### Scharnierseiten

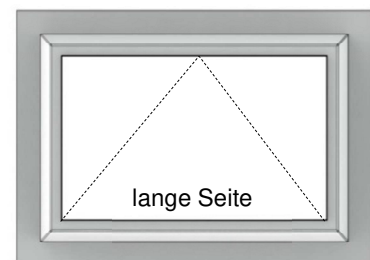
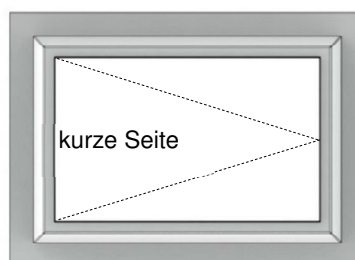



## Basisinformation

### Verriegelungen



lüftbar verriegelt



starr Z-Blech

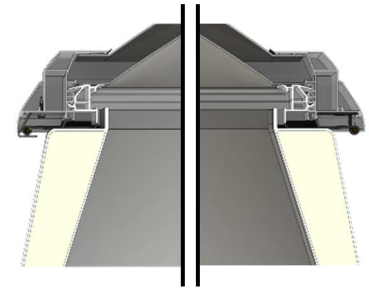

starr beidseitige Scharniere

### Öffner

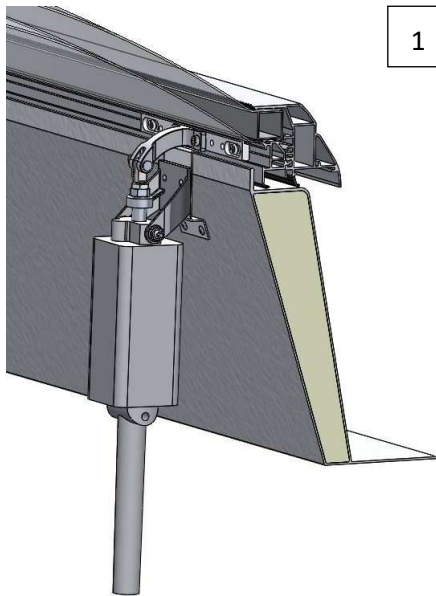

1

Spindelhubantrieb Typ JMBB  
230V  
300mm / 500mm Hub

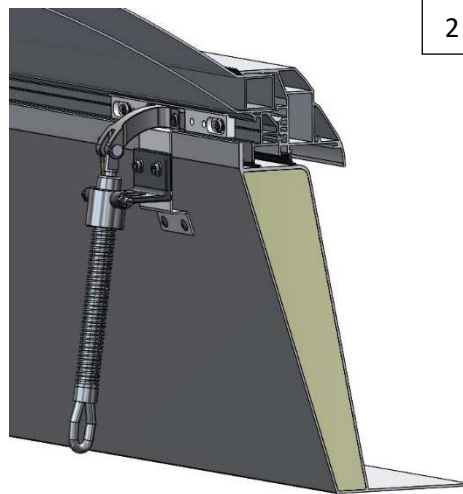

2

Handspindel  
Handbetrieb  
285mm Hub

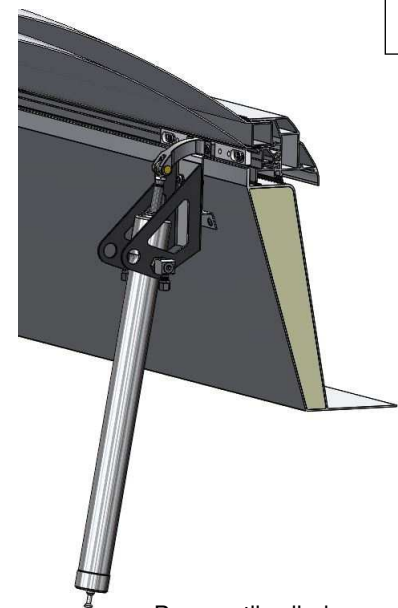

3

Pneumatikzylinder  
pneumatisch  
300mm / 500mm Hub

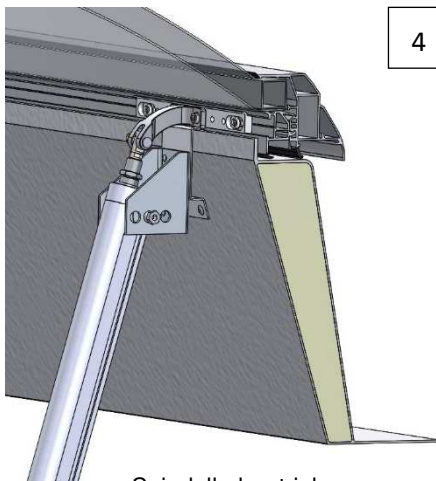

4

Spindelhubantrieb  
Typ Jo65 / Jo100, 24V  
300mm / 500mm Hub

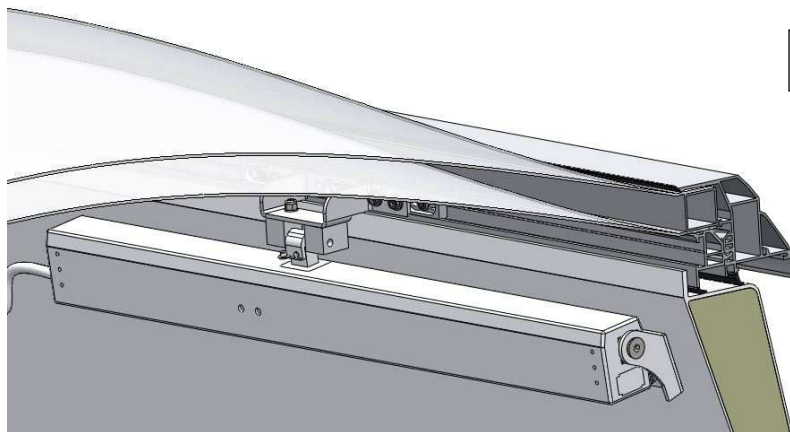

5

Kettenschubantrieb  
230V oder 24V  
300mm / 500mm Hub